

Tension link

With thin-film technology from 5 kN

Models F7301, F73C1, F73S1

WIKA-data sheet FO 51.19



Applications

- Crawler cranes, mobile cranes, harbour cranes, for recording load and torque
- Conveyor systems
- Drives and winches
- Cable winch measurement
- Ship-lifting facilities

Special features

- Measurement ranges from 0 ... 5 kN
- Fine-grained structural steel with high-quality surface protection or corrosion-resistant stainless steel version
- High long-term stability, high shock and vibration resistance, excellent reproducibility
- For dynamic and static measurements
- Option: Redundant output signals

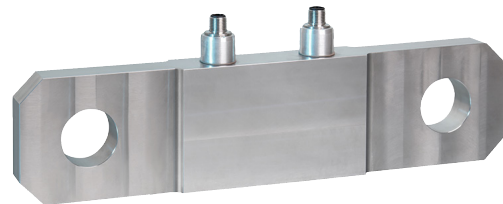

Fig. top: Tension link, model F7301

Fig. bottom: Tension link, model F73C1

Description

Tension links are designed for static and dynamic measurement tasks in the direct flux of force. As a load-bearing component in existing constructions, they determine the tension forces in a wide scope of applications.

Tension links of this series are often used in hoist and crane systems as torque support or rope fix point for load measurements. Further application areas are special machine constructions, e. g. in polymer processing machines. Appropriate technical and regional approvals are available as an option.

The tension links of the series F7301 are either made of high-strength, corrosion-resistant stainless steel 1.4542 or robust fine-grained steel with surface protection. Due to their properties, these materials are particularly suitable for the applications of tension links.

Besides the standard active current and voltage outputs (4 ... 20 mA / 0 ... 10 V), digital outputs (CANopen®) are available as output signals.

Redundant output signals are possible.

These force transducers are a part of our certified product ELMS1 overload protection (DIN EN ISO 13849-1 with PL d/ Kat. 3 and SIL 2).

Technical data in accordance with VDI/VDE/DKD 2638

Models	F7301	F73S1
Rated force F_{nom} kN	from 5	
Relative linearity error $d_{lin}^{1)}$	$\pm 0.5 \% F_{nom}$	
Relative repeatability error in unchanged mounting position b_{rg}	$\pm 0.05 \% F_{nom}$	
Temperature effect on <ul style="list-style-type: none"> ■ characteristic value TK_C ■ zero signal TK_0 	0.2 % $F_{nom}/10$ K 0.2 % $F_{nom}/10$ K	
Force limit F_L	150 % F_{nom}	
Breaking force F_B	300 % F_{nom}	
Shear force influence d_Q (Signal with 100 % F_{nom} under 90°) 2)	$\pm 2 \% F_{nom}$	
Rated displacement (typ.) s_{nom}	< 0.1 mm	
Material of measuring device	Corrosion resistant stainless steel or fine-grained steel with surface protection, ultrasonic tested 3.1 material (optionally 3.2)	
Rated temperature $B_{T, nom}$	-20 ... +80 °C	
Operating temperature $B_{T, G}$	-30 ... +80 °C (optional -40...+80 °C)	-30 ... +80 °C
Storage temperature $B_{T, S}$	-40 ... +85 °C	
Electrical connection	Circular connector M 12x1, 4-pin or 5-pin CANopen® 5-pin MIL connector	2-circular connector M 12x1, 4-pin MIL connector
Output signal (rated output) C_{nom}	4 ... 20 mA, 2-wire, 4 ... 20 mA, 3-wire 2 x 4 ... 20 mA, redundant DC 0 ... 10 V, 3-wire 2 x DC 0 ... 10 V redundant CANopen® Protocol in accordance with CiA 301, device profile 404, communication services LSS (CiA 305), configuration of the instrument address and baud rate Sync/Async, Node/Lifeguarding, heartbeat; zero and span $\pm 10 \%$ adjustable via entries in the object directory 3)	Redundant opposing 4 ... 20 mA/ 20 ... 4 mA acc. to the requirements for functional safety Machinery Directive 2006/42/EG
Current consumption	Current output 4 ... 20 mA 2-wire: signal current Current output 4 ... 20 mA, 3-wire: < 8 mA Voltage output: < 8 mA CANopen®: < 1 W	Current output 4 ... 20 mA: signal current
Supply voltage	DC 10 ... 30 V for current output DC 14 ... 30 V for voltage output DC 12 ... 30 V for CANopen®	DC 10 ... 30 V for current output
Burden	$\leq (UB-10 V)/0.024$ A for current output > 10 k Ω for voltage output	$\leq (UB-10 V)/0.020$ A (channel 1) for current output $\leq (UB-7 V)/0.020$ A (channel 2) for current output
Response time	≤ 2 ms (within 10 ... 90 % F_{nom}) 4)	
Protection (acc. to EN/IEC 60529)		
■ unplugged condition	IP66, IP67	IP67
■ plugged condition	IP68, IP69, IP69K	
Electrical protection	Reverse voltage, overvoltage and short-circuit protection	
Vibration resistance	20 g, 100 h, 50...150 Hz (acc. to DIN EN 60068-2-6)	
Noise emission	DIN EN 55011	
Noise immunity	In accordance with DIN EN 61326-1/DIN EN 61326-2-3 (optional EMC-strengthened versions)	
Optional	Certificates, strength verifications, 3D-CAD files (STEP, IGES) on request	

1) Relative linearity error acc. to VDI/VDE/DKD 2638 chap. 3.2.6.

2) This value can be reached when 100 % F_{nom} act. 90° rotated to the axis.

3) Protocol acc. to CiA DS-301 V.402. Device profile DS-404 V. 1.2.

4) Other response times are available on request.

CANopen® and CiA® are registered community trade marks of CAN in Automation e.V.

Models	F73C1 ATEX/IECEX EX ib ¹⁾	F73C1 signal jump
Rated force F_{nom} kN	from 5	
Relative linearity error d_{lin} ²⁾	$\pm 0.5 \% F_{nom}$	
Relative repeatability error in unchanged mounting position b_{rg}	$\pm 0.05 \% F_{nom}$	
Temperature effect on ■ characteristic value TK_c ■ zero signal TK_0	0.2 % $F_{nom}/10$ K 0.2 % $F_{nom}/10$ K	
Force limit F_L	150 % F_{nom}	
Breaking force F_B	300 % F_{nom}	
Shear force influence d_Q (Signal with 100% F_{nom} under 90°) ³⁾	$\pm 2 \% F_{nom}$	
Rated displacement (typ.) s_{nom}	< 0.1 mm	
Material of measuring device	Corrosion resistant stainless steel or fine-grained steel with surface protection, ultrasonic tested 3.1 material / (optionally 3.2)	
Rated temperature $B_{T, nom}$	-20 ... +80 °C	
Operating temperature $B_{T, G}$	Ex II 2G Ex ib IIC T4 Gb -25 °C < Tamb < +85 °C Ex II 2G Ex ib IIC T3 Gb -25 °C < Tamb < +100 °C Ex I M2 Ex ib I Mb -25 °C < Tamb < +85 °C Ex II 2G Ex ib IIC T4 Gb -40 °C < Tamb < +85 °C Ex I M2 Ex ib I Mb (for cable connection only)	-30 ... +80 °C
Storage temperature $B_{T, S}$	-40 ... +85 °C	
Electrical connection	Circular connector M 12x1, 4-pin MIL connector Cable gland	Circular connector M 12x1, 4-pin Cable gland
Output signal (rated output) C_{nom}	4 ... 20 mA, 2-wire	4 ... 16 mA, 2-wire ⁴⁾ DC 2 ... 8 V, 3-wire ⁴⁾
Current consumption	Current output 4 ... 20 mA 2-wire: signal current	Current output 4 ... 20 mA 2-wire: signal current, Current output 4 ... 20 mA 3-wire: < 8 mA, Voltage output: < 8 mA
Supply voltage	DC 10 ... 30 V for current output	DC 10 ... 30 V for current output DC 14 ... 30 V for voltage output
Burden	< (UB-10 V)/0,024 A for current output > 10 kΩ for voltage output	
Response time	≤ 2 ms (within 10 ... 90 % F_{nom}) ⁵⁾	
Protection (acc. to EN/IEC 60529)	IP67	
Electrical protection	Reverse voltage, overvoltage and short-circuit protection	
Vibration resistance	20 g, 100 h, 50...150 Hz acc. to DIN EN 60068-2-6	
Noise emission	DIN EN 55011	
Noise immunity	In accordance with DIN EN 61326-1/DIN EN 61326-2-3 (optional EMC-strengthened versions)	
Optional	Certificates, strength verifications, 3D-CAD files (STEP, IGES) on request	
Certificates (optional)	ATEX: acc. to EN 60079-0:2012 and EN 60079-11:2012 (Ex ib) IECEX: acc. to IEC 60079-0:2011 (Ed.6) and IEC 60079-11:2011 (Ed. 6) (Ex ib) UL: acc. to UL 61010-1 and CSA C22.2 NO. 61010-1	

1) The tension links with ignition protection type "ib" must only be supplied using galvanically-isolated power supplies.







2) Relative linearity error acc. to VDI/VDE/DKD 2638 chap. 3.2.6.

3) This value can be reached when 100 % F_{nom} act. 90° rotated to the axis.

4) Other signal jumps are available on request.

5) Other response times are available on request.

Approvals

Logo	Description	Country
	EU declaration of conformity <ul style="list-style-type: none"> ■ EMC directive ■ RoHS directive 	European Union
	ATEX directive (option) Please note the additional information for Ex devices Hazardous areas Ex ib Ex II 2G Ex ib IIC T4 Gb $-25\text{ °C} < T_{\text{amb}} < +85\text{ °C}$ Ex II 2G Ex ib IIC T3 Gb $-25\text{ °C} < T_{\text{amb}} < +100\text{ °C}$ Ex I M2 Ex ib I Mb $-25\text{ °C} < T_{\text{amb}} < +85\text{ °C}$ Ex II 2G Ex ib IIC T4 Gb $-40\text{ °C} < T_{\text{amb}} < +85\text{ °C}$ I M2 Ex ib I Mb (only available with cable connection)	European Union
	IECEx (option) Hazardous areas Ex ib Ex ib IIC T4/T3 Gb $-25\text{ °C} < T_{\text{amb}} < +85\text{ °C}$ Ex ib IIC T4 Gb $-25\text{ °C} < T_{\text{amb}} < +100\text{ °C}$ Ex ib I Mb $-25\text{ °C} < T_{\text{amb}} < +85\text{ °C}$ Ex ib IIC T4 Gb $-40\text{ °C} < T_{\text{amb}} < +85\text{ °C}$	International
	UL <ul style="list-style-type: none"> ■ Component approval 	USA and Canada
	KTA <ul style="list-style-type: none"> ■ Safe operation of nuclear facilities 	International
	EAC <ul style="list-style-type: none"> ■ EMC directive 	Eurasian Economic Community

Dimension/Mounting situation of the tension link

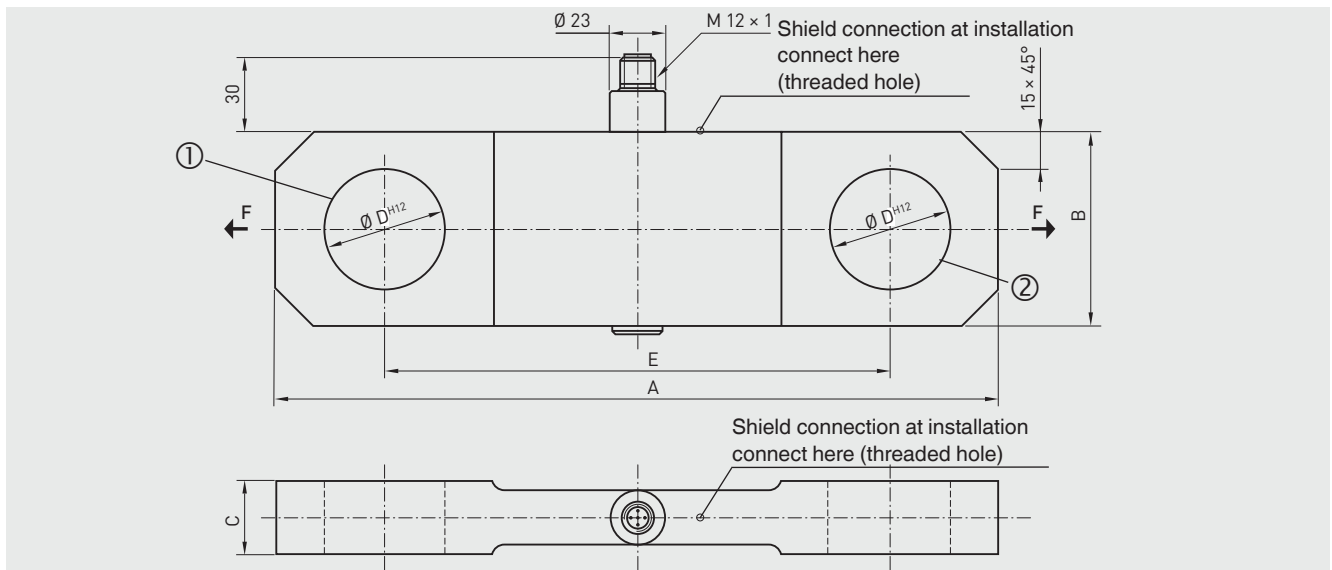

Dimensions: The customer-specific transducer drawing for the specific article number applies above all.

For the F7301, F73C1, F73S1 series, there are no standard dimensions. All dimensions in mm.

Insert the corresponding bolts on both sides, ① and ②, into the corresponding bores. Load the tension link with tension force (F).

Pin assignment analogue output

4 ... 20 mA output, 2-wire

Circular connector M12 x 1, 5-pin

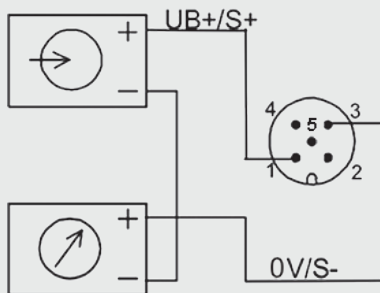

0 ... 10 V output, 3-wire

Circular connector M12 x 1, 5-pin

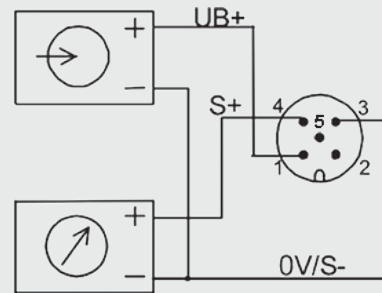

Circular connector M12 x 1, 5-pin

	4 ... 20 mA 2-wire	4 ... 20 mA 3-wire	0 ... 10 V 3-wire
Supply UB+	1	1	1
Supply 0V/UB-	3	3	3
Signal S+	1	4	4
Signal S-	3	3	3
Screen ⊕	Case	Case	Case

Cable outlet

Cable colour	2-wire	3-wire
Brown	UB+/S+	UB+
White	-	-
Blue	0V/S-	0V/S-
Black	-	S+

Only when using the standard cable, e.g. EZE53X011016

Pin assignment ATEX/IECEX

Circular connector M12 x 1, 4-pin

	ATEX Ex ib 4...20 mA, 2-wire
Supply UB+	1
Supply 0V/UB-	3
Signal S+	1
Signal S-	3
Screen ⊕	Case

Cable outlet

Cable colour	2-wire
Brown	UB+/S+
White	-
Blue	0V/S-
Black	-

Only when using the standard cable, e.g. EZE53X011016

Pin assignment signal jump

Circular connector M12 x 1, 4-pin			
	4...20 mA 2-wire	4...20 mA 3-wire	0...10 V 3-wire
Supply UB+	1	1	1
Supply 0V/UB-	3	3	3
Relay UR+	2	2	2
Relay UR-	4	3	3
Signal S+	1	4	4
Signal S-	3	3	3
Screen ⊕	Case	Case	Case

Cable outlet		
Cable colour	2-wire	3-wire
Brown	UB+/S+	UB+
White	UR+	UR+
Blue	0V/S-	0V/S-/UR-
Black	UR-	S+

Only when using the standard cable, e.g. EZE53X011016

Pin assignment, analogue output, redundant, opposing

Circular connector M12 x 1, 4-pin		
	4 ... 20 mA / 20 ... 4 mA (redundant)	
	Connector 1	Connector 2
Supply UB+	1	1
Supply 0V/UB-	3	3
Signal channel 1	4	-
Signal channel 2	-	4
Screen ⊕	Case	Case

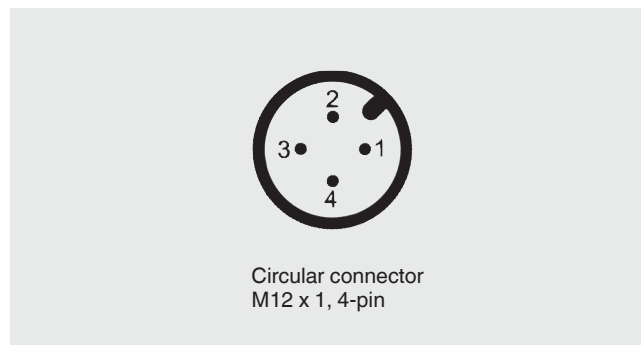

2-connector variant, for example, in combination with ELMS1 overload protection (F73S1).

Version in accordance with requirements for functional safety per 2006/42/EC Machinery Directive.

Pin assignment, analogue output with MIL connector

MIL	mA/V 3-wire		mA/V 2-wire	
A	UB+	Channel 1	UB+ / S+	Channel 1
C	0V / S-		0V / S-	
D	S+	Channel 2	UB+ / S+	Channel 2
B	UB+		-	-
E	0V / S-		-	-
F	S+		0V / S-	Channel 2
G	-	-	-	-
Screen ⊕	Case	-	Case	-

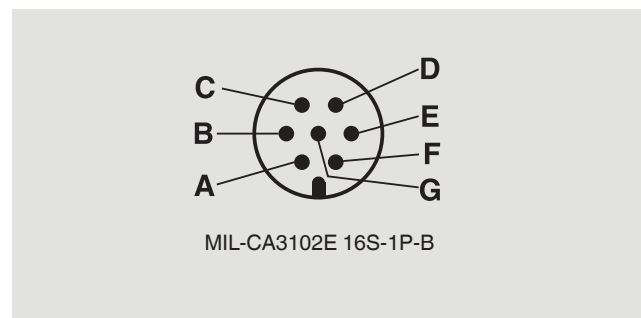

Pin assignment CANopen®

Circular connector M12 x 1, 5-pin	
Screen ⊕	1
Supply UB+ (CAN V+)	2
Supply UB- (CAN GND)	3
Bus-Signal CAN-High	4
Bus-Signal CAN-Low	5

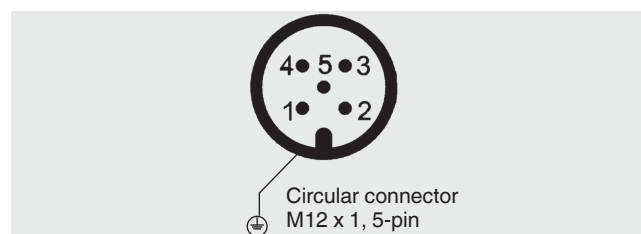

Connect the cable shield to the force transducer housing. In the case of accessory cables, the cable shield must be connected with the knurled nut and thus connected to the housing of the force transducer. When extending, only shielded and low capacitance cables should be used. The permitted maximum and minimum lengths of the cable are specified in ISO 11898-2. A high-quality connection of the shielding must also be ensured.

Short description of signal jump electronics

Amplifier electronics 4 ... 20 mA or 0 ... 10 V for signal jump applications with 2-channel PC control

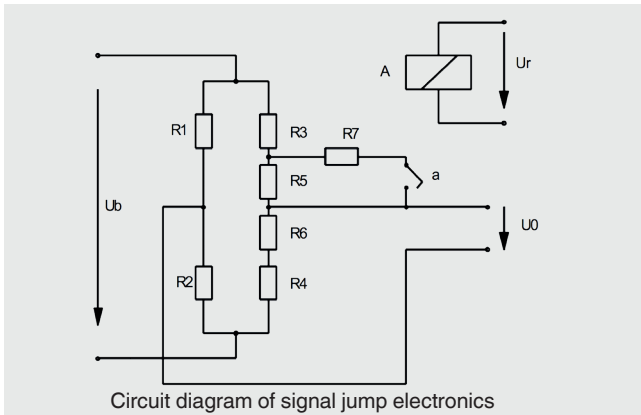

These force transducers are working with four variable resistors (R1 ... R4) connected to a Wheatstone Bridge. Caused by deformation of the body the respective opposite resistors are lengthened or compressed in the same way. This results in an unbalanced bridge and a diagonal voltage U_0 .

This well proven design has been amended by an additional resistor R7 in order to monitor the condition of the amplifier unit and signal path. This resistor is connected as a shunt to resistor R5 by a relay contact (a) as soon as an excitation voltage U_r appears at relay A. The connection of resistor R7 will always result in a defined unbalancing of the zero point (diagonal voltage) of the Wheatstone Bridge.

Compliance with functional safety

An external safety controller independently of the force transducer must monitor the safe functioning of the force transducer. The function test with a signal jump of 4 mA / 2 V is generated at a 24-hour interval. The safety controller activates relay A and thus defines the output signal of the force transducer.

If the expected change in the output signal occurs, it can be assumed that the entire signal path of the Wheatstone bridge via the amplifier to the output functions correctly.

If it does not occur, an error in this signal path can be concluded. Furthermore, the measuring signal is to be checked by the safety controller for the Min- (A) and Max- (B) signal values in order to detect a possibly arising line break or short circuit.

The standard adjustment of force transducers with current output 4 ... 20 mA for overload control is e.g.:

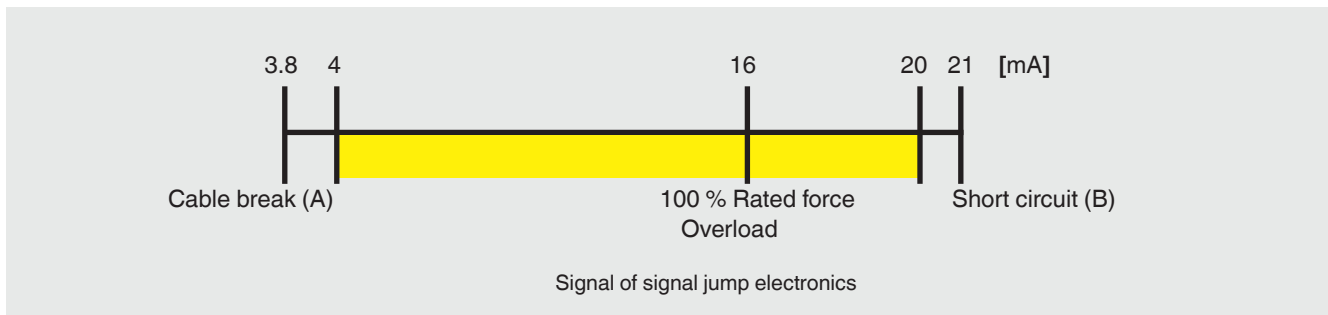

With a fixed signal level of, for example, 4 mA, the testing cycle can be triggered in every operating status upon activation of the check relays. The measurement's upper limit

of 20 mA will not be reached. This enables a check of the signal level.

© 09/2021 WIKA Alexander Wiegand SE & Co. KG, all rights reserved.
The specifications given in this document represent the state of engineering at the time of publishing.
We reserve the right to make modifications to the specifications and materials.

